

SPD360C







LIFT ANYWHERE YOU NEED!



**UNI EN 12999
ANSI/ASME B30.5-2004**



TECHNICAL SHEET • DATI TECNICI • TECHNISCHE DATEN • DATOS TÉCNICOS • CARACTERISTIQUES TECHNIQUES

						
Dimensions	Dimensioni	Abmessungen	Dimensiones	Dimensions	3100x800x1900	mm
Weight	Peso	Gewicht	Peso total	Poids	2.200	kg
Loading momentum	Momento di sollevamento	Aufhebenmoment	Momento de elevación	Couple de levage	4.300	kgm
Maximum SWL	Portata massima	Max. Tragfähigkeit	Carga máxima	Portee max.	1.800	kg
Rotation	Rotazione	Umdrehung	Rotación máx.	Rotation	360	°
Tilting	Angolo braccio	Auslegerverstellwinke	Inclinación de la pluma	Angle flèche	-2/+73	°
Max SWL for winch-single fall	Portata argano (tiro singolo)	Hubwerk-Tragfähigkeit (Einzelzug)	Carga cabrestante (tiro directo)	Portée treuil (tir unique)	600	Kg
Winch rope length	Fune	Seil	Longitud cable	Cable de levage	60	m
Controls	Comandi	Steuerung	Mandos	Commande	electrical & proportional elettrico proporzionali Elektrische Proportionalsteuerung eléctricos, proporcionales électrique et proportioneel	
Drive system	Trazione	Antrieb	Tracción	Traction	hydrostatic idrostatica Hydrostatischer Antrieb hidroestática hydrostatique	
Max gradient	Pendenza superabile	Steigfähigkeit	Pendiente superable	Pente a dépasser	20	°
Track area	Impronta cingoli	Raupeneindruck	Medida orugas	Empreinte chenille	1080x230x2	mm
Max track loading	Pressione al suolo	Druck am Boden	Presión de apoyo	Pression au sol	0,44	Kg/cm ²
Outriggers	Stabilizzatori	Stabilisatoren	Estabilizadores	Vérin de stabilité	hydraulic, multi position idraulici orientabili hydraulische, schwenkbare, hidráulicos, orientables hydraulique, orientable	
Max outrigger load	Reazione massima	Max. Reaktion	Reacción máxima	Reaction maximum	1.900	Kg
Standard Equipment	Dotazione di serie	Serienmäßige Ausrüstung:	Equipamiento estándar	Dotation de série		
Stability control system (SCS), Pressure relief valves, Overcentre lock valves, n°4 Outrigger pads, Battery charger, Remote control, Winch load limiter Controllo stabilità (SCS), Valvole di massima pressione, Valvole di blocco bilanciate, n°4 calzatoie 400x400, Caricabatterie, Radiocomando, Limitatore di tiro argano Stabilitätsprüfung (SCS), Hochsdruckventile, Absperrventile, 4 hemmschuhe 400x400, Ladegerät, Hubwerk-Zugbegrenzer Control de estabilidad (SCS), Válvulas de max. presión, Válvulas de bloqueo balanceadas, 4 calzos 400x400, Cargador, Radiomando, Limitador cabrestante. Contrôle stabilité (SCS), Soupapes de max. pression, Soupapes d'arrêt balancées, n°4 paltines d'arrêt 400x400, Charge batterie, Limiteur tir treuil.						
Optional Equipment	Optional	Zubehöre	Accesorios	Accessoires		
3 Phase Kit, Colour, Working light, Double pulley, Jib 600M Kit trifase, Colore, Faro di lavoro, Bozzello tiro doppio, Jib 600M Dreiphasiger Kit, Farbe, Arbeitsscheinwerfer, Seilblock, Jib 600M Sistema eléctrico trifásico, Color, Foco de trabajo, Polea ramal doble, Jib 600M Kit triphasé, Couleur, Phare de travail, Poulie à tir double, Jib 600M						
SPD 360 C+						
Motor	Motore	Motor	Motor eléctrico	Moteur	24 V-DC SEP	
Speed	Velocità	Geschwindigkeit	Velocidad	Vitesse	4	
Battery capacity	Alimentazione	Versorgung	Alimentación	Alimentation	n° 4 6V-350Ah	
Motor power	Potenza	Versorgung der elektrischen	Potencia	Puissance	3	kW
Electrical system voltage	Tensione impianto elettrico	Anlage	Tensión instalación eléctrica	Tension systeme électrique	24	V
SPD 360 CD						
Motor	Motore	Motor	Motor eléctrico	Moteur	Lombardini15LD440	
Speed	Velocità	Geschwindigkeit	Velocidad	Vitesse	3	
Fuel	Alimentazione	Versorgung	Alimentación	Alimentation	Diesel	
Tank capacity	Capacità serbatoio	Leistung	Capacidad tanque	Capacité du reservoir	5	l
Specific fuel consumption @ 2800RPM	Consumo specifico a 2800giri	Spezifischer Verbrauch bei 2800	Consumo a 2800RPM	Consommation spécifique à 2800RPM	235	g/kwh
Motor power	Potenza	U/min	Potencia	Puissance	7.4/10.1	kW/hp
Electrical system voltage	Tensione impianto elettrico	Versorgung der elektrischen Anlage	Tensión eléctrica	Tension systeme électrique	12	V

Notes: All specifications and features herein described can be changed without prior advice. All indicated data are indicative only and are not binding as crane performs differently depending on its use.

Note: Tutte le caratteristiche e le specifiche descritte possono essere soggette a variazioni senza preavviso. Tutti i dati riportati sono forniti a puro titolo informativo e non sono impegnativi dal momento che le prestazioni della macchina variano in funzione dell'utilizzo.

Hinweise: Unangekündigte Änderungen sämtlicher Eigenschaften und Daten sind möglich. Alle Angaben sind Richtwerte und nicht verbindlich da die Leistungen der Vorrichtung von deren Einsatz abhängen.

Notas: Todas las características y las especificaciones aquí indicadas pueden ser sujetas a variaciones sin aviso. Se dan todos los datos aquí indicados como simples informaciones. No se consideran como vinculantes, dado que las prestaciones del maquinario pueden variar.

Notes: Toutes les caractéristiques et les spécifications descriptives peut être sujet à variation sans préavis. Tout les données rapportés sont fourni à titre informatif et ne sont pas engager au moment que la prestation de la machine change en fonction de l'emploi.

SPD360C

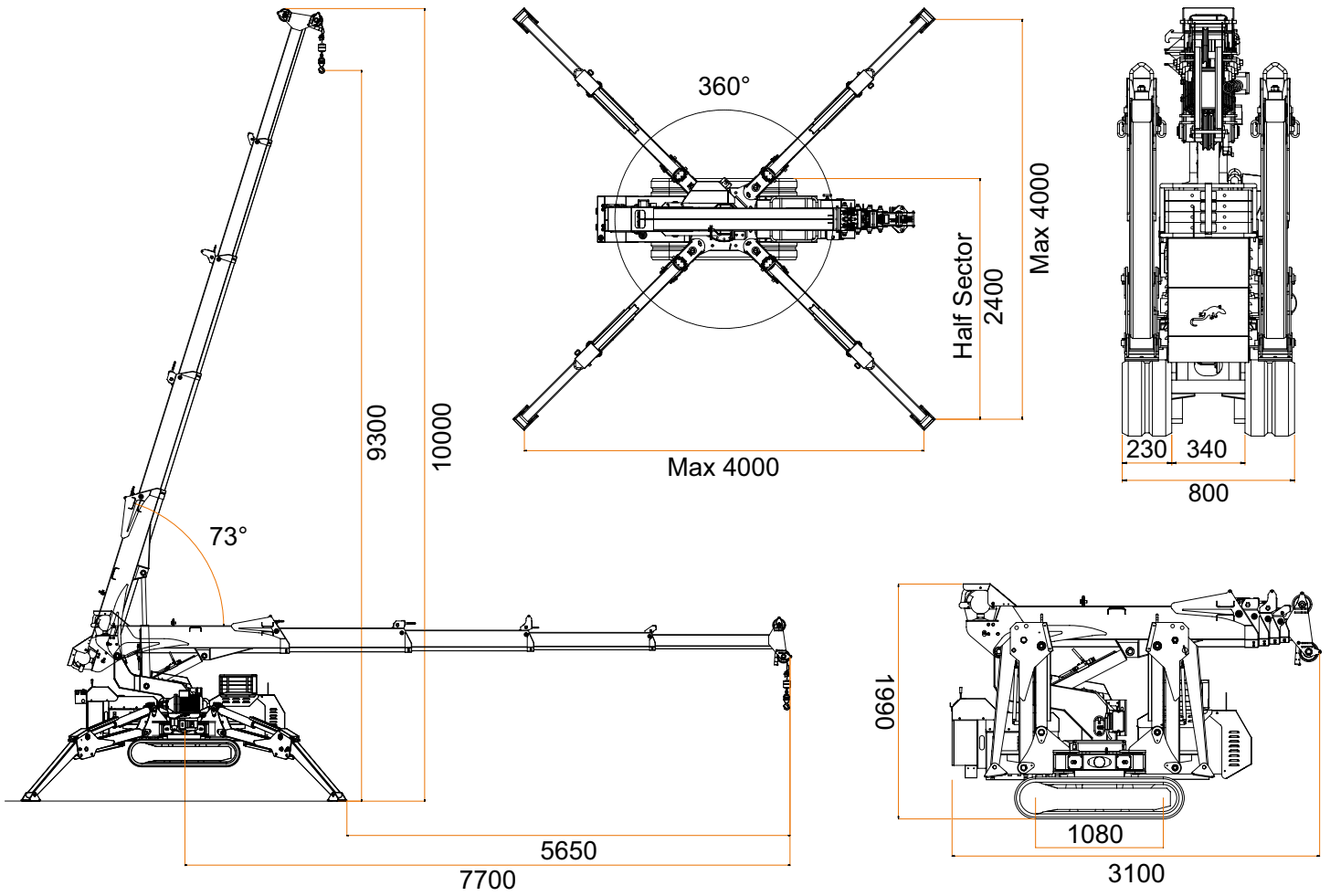

JIB600M

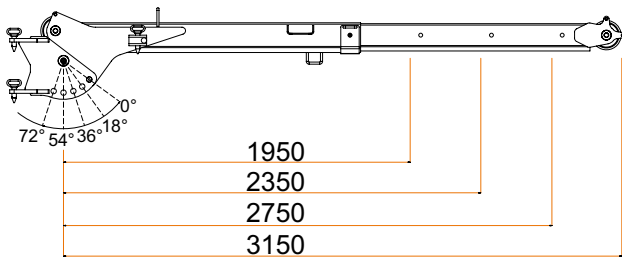

TECHNICAL SHEET • DATI TECNICI • TECHNISCHE DATEN • DATOS TÉCNICOS • CARACTERISTIQUES TECHNIQUES

					
Weight	Peso	Gewicht	Peso total	Poids total	90 Kg.
Max. SWL	Portata massima	Max. Tragfähigkeit	Carga Máxima	Portée max.	600 Kg.
Tilting	Angolo braccio	Auslegerverstellwinke	Inclinación de la pluma	Angle flèche	0°, 18°, 36°, 54°, 72°



Imai srl via Campardone, 7 Z.I. 31014 Colle Umberto TV Italy
 tel. +39 0438.430171 fax +39 0438.430115
 www.imai.it • www.jekko.it • info@jekko.it